

Top View

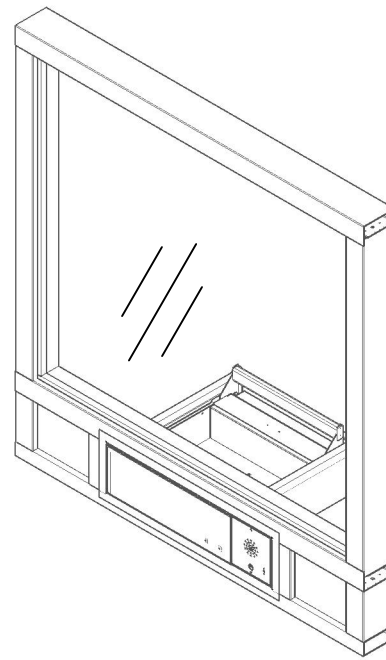

Exterior Back View

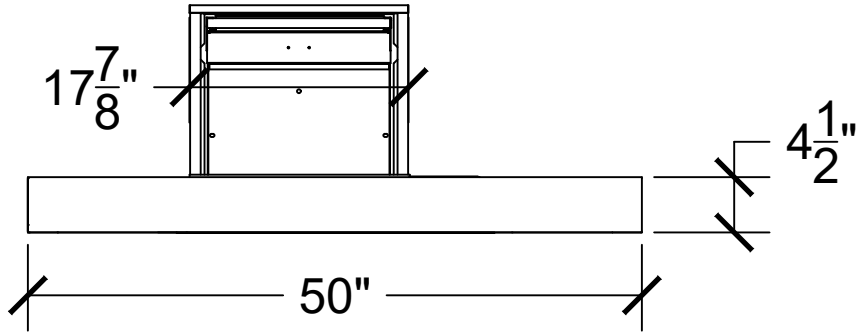
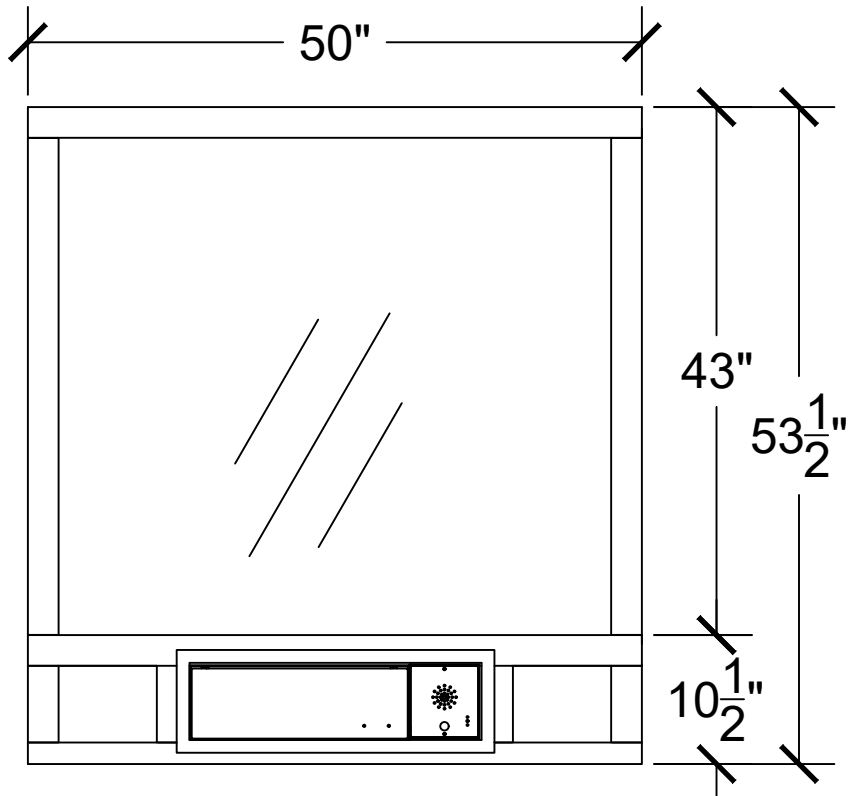

Side View

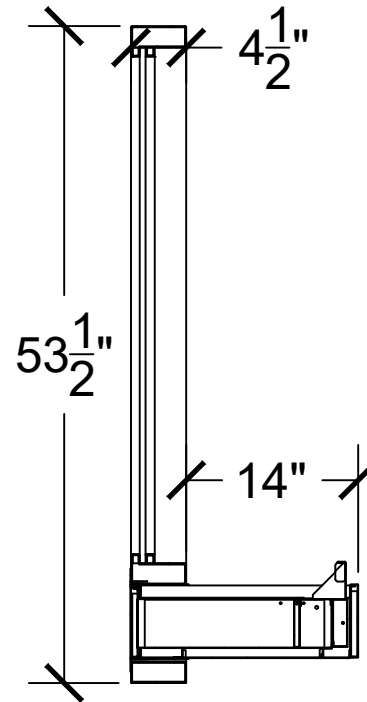

COVENANT
Security Equipment

PLEASE SELECT:

1. FRAMING:

Aluminum Loaded Aluminum

Stainless

2. FRAME COLOR:

Bronze Anodized Clear Anodized

Other: _____

3. GLAZING:

1/4" Tempered

3/4" Poly - L1

1-1/4" Poly - L3

Storm Impact Low-E

1-1/4" Acrylic - L1

1-1/4" Acrylic - L3

Other: _____

Key Notes

Unit:

QST-625S MINI COMBO

Actual Dimension:

50"(W) X 53-1/2"(H)

Rough Opening:

50-3/8"(W) X 53-7/8"(H)

Service Opening:

14 ⁵/₈"(W) X 4 ¹/₂"(H) X 12 ³/₄"(D)

Engineer Notes

Date drawn: 8/5/2021

Drawn by: Avasquez

File name: QST-625S MINI 50 53.dwg

Page: 1 of 1

Scale: 1:16

NOTE: THIS DRAWING EMBODIES A CONFIDENTIAL PROPRIETY DESIGN ORIGINATED AND OWNED BY COVENANT SECURITY EQUIPMENT, AND IS SUBMITTED UNDER A CONFIDENTIAL RELATIONS ALL PATENT, MANUFACTURING, SALE RIGHTS REGARDING THE SAME ARE RESERVED EXCEPT TO THE EXTENT RIGHTS ARE EXPRESSLY GRANTED TO OTHERS. THE RECIPIENT AGREES BY ACCEPTING THESE DRAWINGS NOT TO SUPPLY OR DISCLOSE ANY INFORMATION REGARDING THEM TO ANY UNAUTHORIZED PERSONAL.

SIGNATURE: _____

DATE: _____